



600881 (E1HCEEOMCS) Plug-in Induction Wok

Main Features

- Automatic pan detection to transfer power only when pan is present
- High impact, heavy duty glass-ceramic wok bowl for durability and easy cleaning.
- 2-color user interface (white and red) for better readability.
- Plug in unit designed for table top installations.
- Glass touch display on top for maximum visibility.
- Power level settings from 1 to 10.
- Timer function can be used to set the cooking time, switching off the zone automatically at the end of the time set
- Self-diagnostics: an error code is displayed (Exxx) in case of dysfunction.
- Designed for LiberoPro Duo function for automatic regulation of the LiberoPro Point fan speed according to cooking intensity.

Construction

- IPx4 water protection.
- One induction wok shaped bowl 6mm thick.
- 4 sides unique frame in AISI 304 2 mm thick.
- Induction air filters easy to clean and remove for monthly cleaning.
- 4 feet, cord and plug included.

Sustainability

- Rapid heat transfer directly to the pan, no heat is dispersed into the environment
- This model is compliant with Swiss Energy Efficiency Ordinance (730.02).

Optional Accessories

PNC Code	Description
Pots and pans	
910613	Induction Wok pan with wooden handle (diam. 360mm)
911000	Stainless steel wok pan, design in line with wok cuvette
911003	Non-stick wok pan, design in line with wok cuvette



Recommended Detergents

PNC Code	Description
OS2881	S01 STAINLESS STEEL SURFACE POLISHER; 6 BOTTLES X 750ML C/T
OS2882	S02 Degreaser for ovens and SpeedDelight. Specific for cleaning the cooking chambers of GourmeXpress and SpeeDelight. Active up to a maximum of 50°C Complete with spray bottle Pack of 6 750ml bottles
OS2883	S03 ALCOHOL BASE DETERGENT; 6 BOTTLES X 750ML; ADR&IMDG&IATA Limited Quantity
OS2884	S04 GLASSES & HARD SURFACES CLEANERS; 6 BOTTLES X 750ML



Technical specifications

Electric

Supply voltage:	220-240 V/1N ph/50-60 Hz
Total Watts:	3.5 kW
Plug type:	CE-SCHUKO
Minimum Circuit Ampacity (MCA):	16A

Key Information:

External dimensions, Width:	400 mm
External dimensions, Depth:	600 mm
External dimensions, Height:	229 mm
Net weight:	21 kg

Side

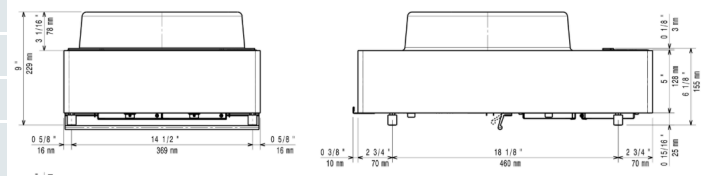

Top

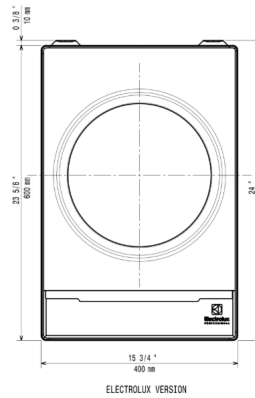

Other

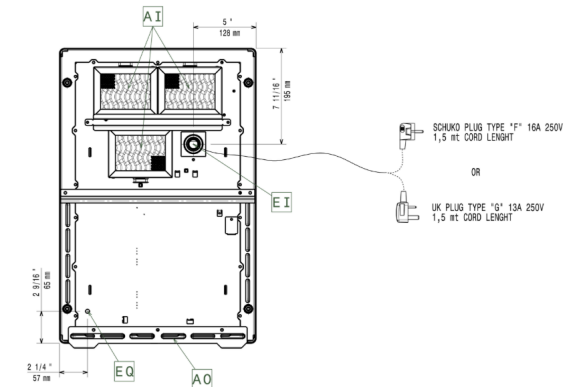

EI = Electrical inlet (power)
EO = Electrical Outlet



Find out more:
ISO Certificates
Electrolux Professional Recognitions

The company reserves the right to make modifications to the products without prior notice. All information correct at time of printing.

2026/06/24

3/3